

Installation/Operating Instructions

MEC Screen by Progressive Sports Construction Group

Caution

- ① This equipment should not be installed, operated or maintained by any person who has not read all the contents of these instructions.
- ② Operates on 110-120v AC, 60 Hz current.
- ③ Before connecting switches, controls, or electrical, make sure **power is off**. Wiring indicated in diagram by dashed lines **must be completed by an electrician**.
- ④ Locate the Touch Panel so it is within clear view of the equipment being operated; it should also be in a location that will minimize the chance of damage.

Installation

- ① Mount the Control Processor in a safe location, with access to standard 110-120V AC.
- ② The Touch Panel should be mounted per separate instruction section, and wired as indicated in wiring diagrams on page 4. The Touch Panel should be in clear view of the equipment being operated, but should also be in a location that will minimize the chance of damage.
- ③ Mount Relay Panel (s) in locations as desired.
- ④ Set Network I.D. for each relay panel as shown at Point 2 in Figure 1. Turning dial "H" sets the first digit of the network I.D. and turning dial "L" sets the second digit. Each relay panel must have the correct Network I.D. or your system will not function properly. The Network I.D. is indicated on project specific Relay Panel Worksheets that are supplied with the product shipment.

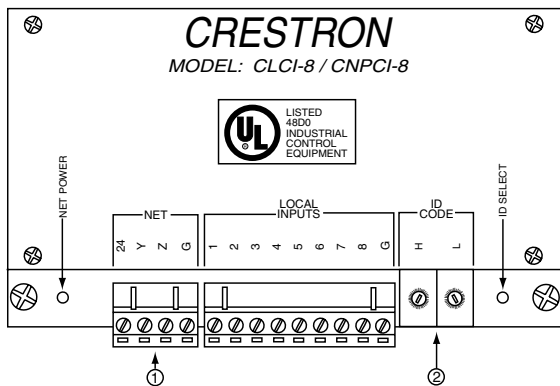

Figure 1

- ⑤ Equipment to be operated should be connected to the relays as indicated on project specific Relay Panel Worksheets that are supplied with the product shipment. Be sure to remove the metal jumpers that are installed between the two poles of each relay. Progressive Sports Construction Group's suggested wiring for each type of equipment is shown in the wiring diagrams found on page 4.
- ⑥ Connect low voltage control wire to Point 1 on Fig. 1. Wire sizes and connections should be as shown on the wiring diagrams on page 4.

Mounting MEC Screen Touch Screen

NOTE: When mounting the MEC Screen Touch Screen into an electrical box, the box must be installed horizontally.

To mount the MEC Screen Touch Screen into an electrical box, use the following procedure:

- ① Use a small slot head screwdriver to gently separate the back of the MEC Screen Touch Screen.

- ② Use the two included #06-32 x 1 1/2" screws to attach the back panel to a horizontally mounted electrical box (see Fig. 2).

NOTE: Use the left and right screw holes for attachment to the electrical box.

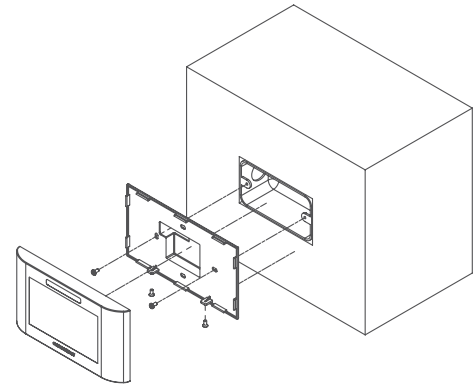

Figure 2

- ③ Carefully position the front of the MEC Screen Touch Screen over the back panel and gently snap it into place (see Fig. 2).
- ④ Use two of the included #04-40 x 1/4" screws to secure the MEC Screen Touch Screen to back panel (see Fig. 2).

Operating Instructions

- ① Your MEC Screen Control System has been programmed specifically for your project, so the controls should be very user friendly. You should operate the system by pressing the appropriate selection on each page as you navigate through the system on the touch screen.
- ② Your MEC Screen System has been pre programmed with a password of 1234. You should program a new password immediately after the system is operational to protect from unauthorized usage. Password should never be given to students or other unauthorized individuals and the password should be changed periodically and after personnel changes to insure security. If the password is ever lost or forgotten, call Progressive Sports Construction Group at (877) 413-0957.
- ③ When finished operating equipment, you should press the Home Button to return the screen to the initial screen to prevent unauthorized usage (After a few minutes it will return to the initial screen by default).

Following is a detailed explanation of the navigation and operation of a typical MEC Screen Control System. Your MEC Screen has been programmed for your specific project conditions, so it may not exactly match the examples. However, the basic steps and general idea will be the same. You should always carefully read each screen and make the proper selection based on the desired operation.

There are two specific buttons that are used to help navigate the MEC Screen System. Below are detailed explanations of these buttons.

Please Note: Join numbers shown in the illustrations are only visible at the programming level and will not be displayed when the MEC Screen is in use.

Navigation Buttons

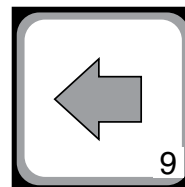

This is the Back Button. When this button is pressed, the touchscreen will return to the screen that was viewed prior to the screen currently displayed.

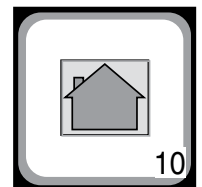

This is the Home Button. When this button is pressed, the touchscreen returns to the initial screen. You will need to re-enter the password after you have returned to the initial screen.

Continued on page 2



If you encounter any difficulty installing or servicing your MEC Screen, call your dealer or Progressive Sports Construction Group, (877) 413-0957 or fax (765) 987-7142.

Initial Screen

Touch anywhere on the screen to progress to the Password entry screen. If the touch screen is blank, the screen has gone into sleep mode. Touch anywhere on the screen to bring up the initial screen.



MEC SCREEN

Password Screen

Enter four-digit password by touching the appropriate numerals, then pressing the "ENT" button. As new digits are entered a star will appear in the top center of the screen beside the phrase "Enter Password." If the user mistakenly presses an incorrect numeral they can press the "CLR" button and start over.



Incorrect Password Screen

This screen appears only if user enters an incorrect password. User should press "Retry" or "Exit."

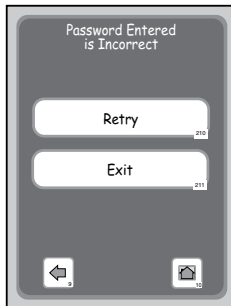

Operation Selection Screen

This screen appears only after the user has entered the correct password. The user then should make the appropriate selection for the function they wish to perform.

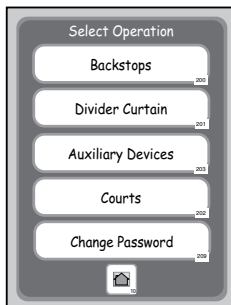

Backstop Selection Screen

This screen appears when the user selects "Backstops" on the Operation Selection Screen. The user should select the backstop they want to operate.



Backstop Operation Screen

This screen appears after the user selects the backstop they want to operate. Press the appropriate button for the direction you want to run the backstop. For safety reasons, directional buttons are momentary contact so the user will need to touch the button for the full run cycle. When the button is released, the backstop motion will stop. Backstop winches are equipped with limit switches that, when properly set, will stop the motion at the appropriate point, so the user should keep the button pressed until motion stops by itself.



Divider Curtain Operation Screen

This screen appears after the user selects Divider Curtain from the Operation Selection Screen. If there are multiple dividers, then a Divider Selection Screen will appear. Press the appropriate button for the direction you want to run the divider. For safety reasons, directional buttons are momentary contact so the user will need to touch the button for the full run cycle. When the button is released, the divider motion will stop. Divider winches are equipped with limit switches that, when properly set, will stop the motion at the appropriate point, so the user should keep the button pressed until motion stops by itself.



Auxiliary Device Selection Screen

Appears when the user selects “Auxiliary Devices” on the Operation Selection Screen. The user should select the auxiliary device they want to operate, such as Lights, Scoreboards, P.A. Systems, Window Shades, Bleachers or any number of other electrical devices.

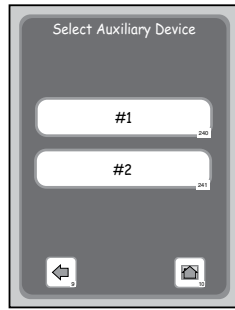

Please Note: Join numbers shown in the illustrations are only visible at the programming level and will not be displayed when the MEC Screen is in use.

Auxiliary Device Operation Screen

This screen appears after the user selects the auxiliary device they want to operate. The illustration below is for an on/off type auxiliary device. If the auxiliary device has a directional motor, the screen would appear very similar to the Backstop Operation or Divider Operation screens.

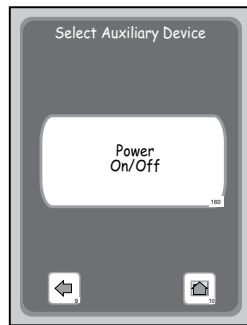

Court Selection Screen

This screen appears when the user selects “Courts” on the Operation Selection Screen. The user should select the court they want to operate. Courts are two backstops that are directly across from one another.

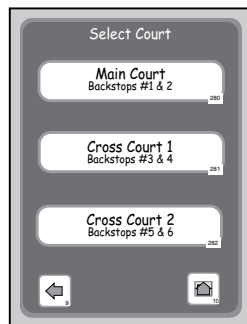

Court Operation Screen

Appears after the user selects the court they want to operate. Press the appropriate button for the direction you want to run the backstops. For safety reasons, directional buttons are momentary contact so the user will need to touch the button for the full run cycle. When the button is released, the backstop motion will stop. Backstop winches are equipped with limit switches that, when properly set, will stop the motion at the appropriate point, so the user should keep the button pressed until both backstops stop moving.

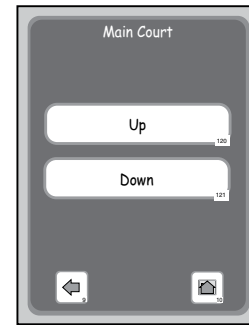

Password Change Confirmation Screen

This screen appears when the user selects “Change Password” on the operation selection screen. The user should push “Yes” if they want to change the password or “No” if they do not wish to change the password.

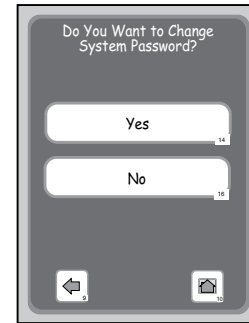

Enter New Password Screen

This screen appears after the user confirms they want to change the password. User should enter new four-digit password then press the “ENT” button in the bottom right. As new digits are entered they will appear in the top center of the screen directly below the phrase "Enter New Password." If user mistakenly presses an incorrect numeral they can press the “CLR” button and start over.



Password Changed Screen

This screen appears after the user enters the new password. The new password will be displayed in the center of the screen. Press “Continue” to return to the Operation Selection Screen.



Please Note: Join numbers shown in the illustrations are only visible at the programming level and will not be displayed when the MEC Screen is in use.

Wiring Diagrams

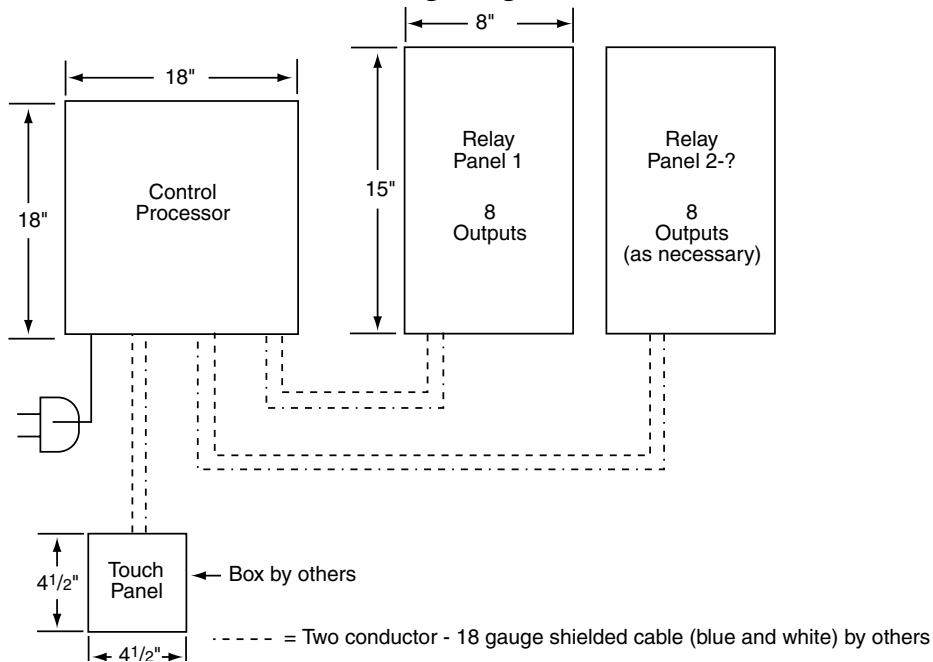

Connections Inside Control Processor Assembly

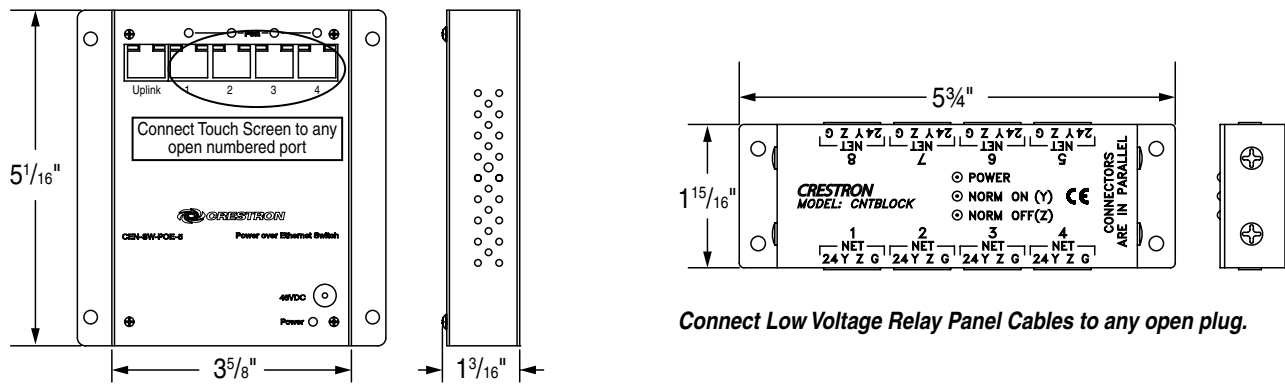

Processor/Relay Panel Cable Connections

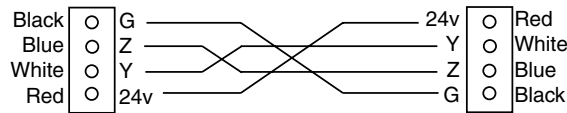

**** NOTE: Up to five MEC Screen devices (relay panels or touch pads) may be connected in a "Daisy Chain" fashion with the low voltage/communication wires running from one device directly to the next.**

Backstops, Divider Curtains, Height Adjusters & Auxiliary Devices
(Bidirectional-Up/Down or In/Out)

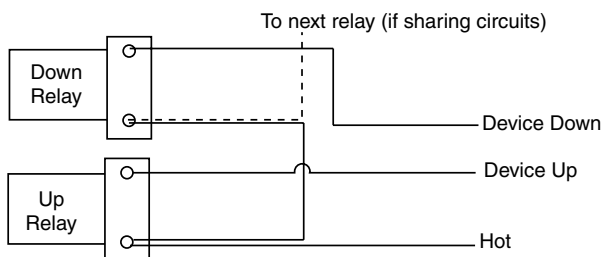

Wire size as recommended by manufacturer of device and/or electrical codes

(On/Off)

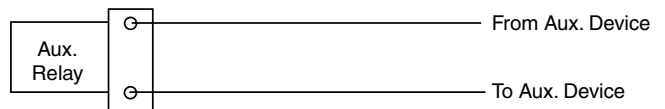

Wire size as recommended by manufacturer of device and/or electrical codes