

Installation/Operating Instructions

Walk-Draw Gym Divider by Progressive

Caution

- ① Locate and identify all parts using the hardware list and the drawings.
"As built" drawings and hardware list are packed in hardware carton. Do not discard with packing material.
 - ② Track must be installed level.
 - ③ Divider must be positively and securely attached.
- These instructions are meant as a guide only. They do not bind Progressive in any way, and do not imply any responsibility of Progressive for improper installation or faulty workmanship at the jobsite.*

Hardware Installation

- ① Verify overall height and width with shop drawing to determine possible discrepancies.
- ② Attach Z-Bracket Assemblies with Flange Clamps to building structure as shown on shop drawing with spacing indicated for track layout.
- ③ Slide track hangers (as supplied) onto sections of track.
- ④ Install track splicer (as supplied) onto ends of track. Track splicers also serve as hangers.
- ⑤ Raise track sections and attach to Z-Bracket Assemblies/Flange Clamps.
- ⑥ Prior to raising the last track section, you may want to slide the trolleys into the track already secured to building structure.
- ⑦ Check with carpenters level to insure track is level. Make adjustments as required.

Curtain Installations

- ① Identify the top of curtain and raise curtain up to the trolleys.
- ② Attach trolleys to the grommets.
- ③ Operate curtain back and forth to insure track is level. Make adjustments as required.

Adjustments

The vertical adjustments in this divider include track elevation and curtain height. Track elevation can be changed by increasing or decreasing the distance between the building structure and track. Small vertical adjustments can be made by adding or subtracting chain links in the trolleys.

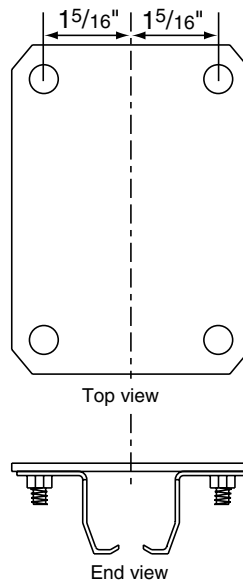
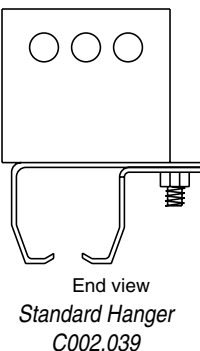
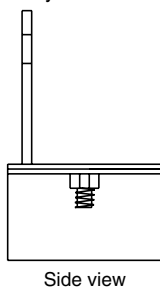
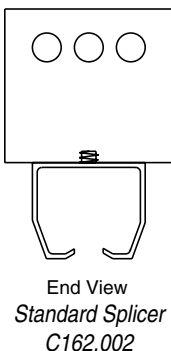
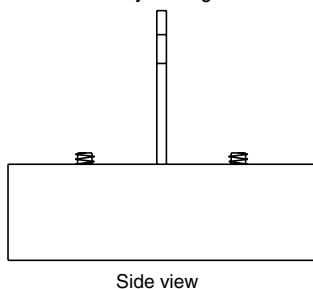
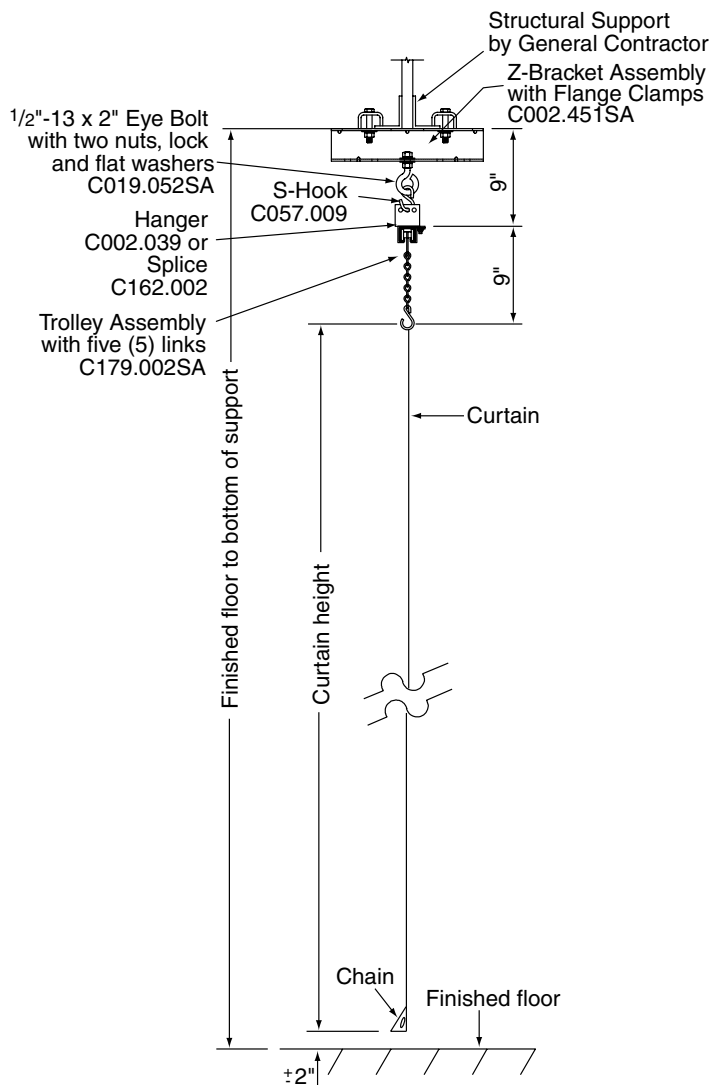

Optional
Flush Mount Splicer
C162.001

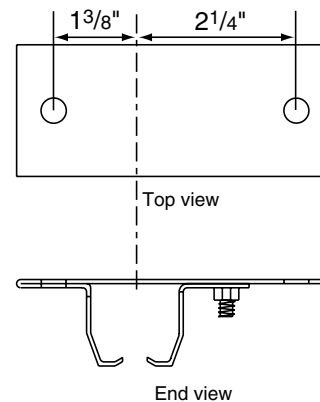

Optional
Flush Mount Hanger
C002.038



765-987-7999
866-637-5611
411 S. Pearl St.
Spiceland IN 47385 USA
www.progressivescg.com

If you encounter any difficulties installing or servicing your Walk-Draw Gym Divider, call your dealer or Progressive (765) 987-7999; or fax (866) 637-5611.